

**DELUXE MODEL B  
EXCLUSIVE FEATURES**

- Built-On Hanging Brackets for Ceiling
- Rugged Construction
- Octagon No-Rub Flat Back Case
- Seamless in All Sizes
- Uniform Automatic Tensioning
- Wrinkle-Free Pictures
- Completely Self-Storing
- Camlok Roller System Prevents Picture Surface From Pulling Off Metal Roller

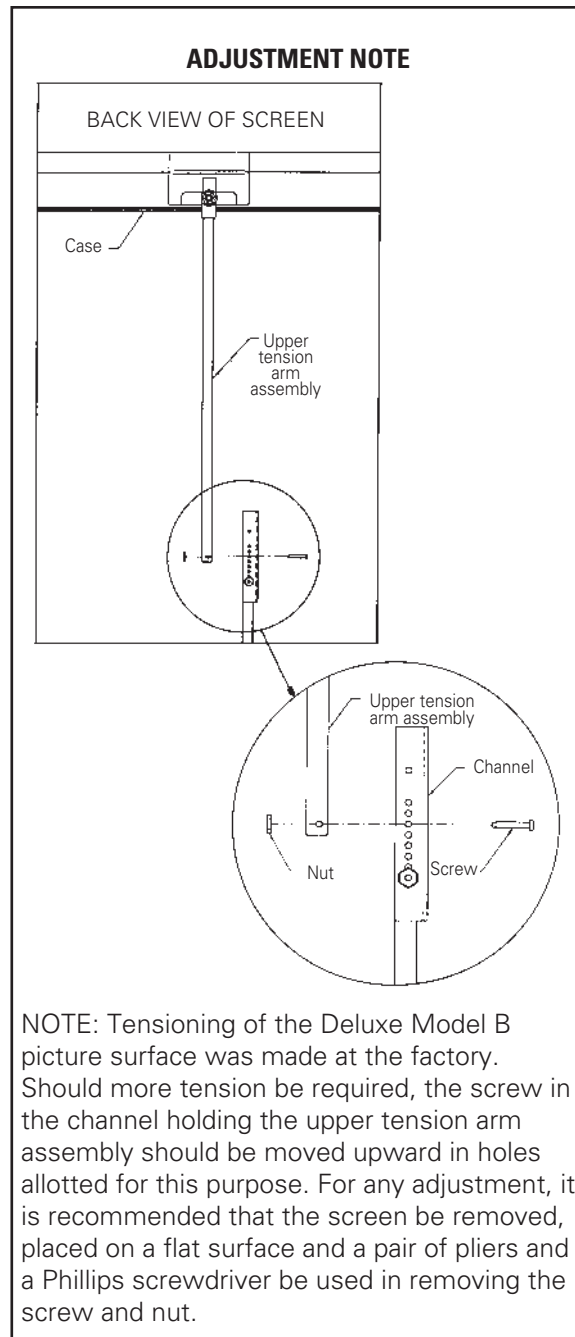

**PROTECT YOUR SCREEN**

Before re-rolling surface into case, examine both front and back of surface to be sure they are free of foreign matter.

**DA-LITE IS MORE  
THAN PROJECTION SCREENS**

Da-Lite Tripod, Wall and Ceiling and Electric Screens

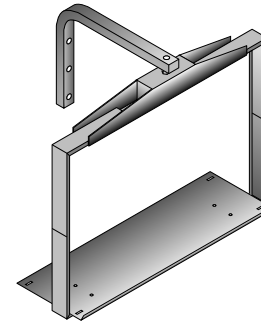
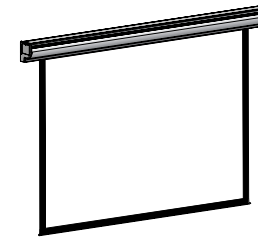

Da-Lite Monitor Mounts

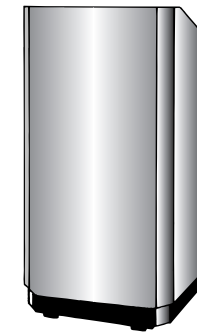

Da-Lite Lecterns



Da-Lite Project-O-Stands and Easels

The **POWER** *In* PRESENTATION PRODUCTS



**Operating Instructions for DELUXE MODEL B®**

**DA-LITE SCREEN COMPANY, INC.**  
3100 North Detroit Street  
Post Office Box 137  
Warsaw, Indiana 46581-0137  
Phone: 574/267-8101  
800-622-3737  
Fax: 574/267-7804  
www.da-lite.com  
e-mail: info@da-lite.com

**YOU HAVE MADE A WISE SELECTION...**

Care in mounting and care in correct operation will mean a long and satisfactory life for your Da-Lite wall/ceiling screen. Locate the screen where the audience can best see it.

**INSTALLATION**

The Deluxe Model B must be suspended from the ceiling or used with extension type wall brackets to allow room for the Automatic Tensionizer.

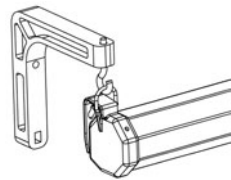

**FOR WALL MOUNTING**

Special extension wall brackets such as Da-Lite's No. 6, No. 11 or No.23 brackets must be used if screen is to be wall mounted. Check with your dealer to determine which best fits your needs.

Brackets should be fastened securely to a solid surface such as a wooden reinforcement board and not in the plaster only. Rarely will wall studs be found to support both ends of a screen. Various types of fasteners are available from local hardware stores.

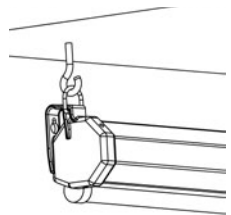

**FOR CEILING SUSPENSION**

If the screen is to be ceiling mounted, two screw hooks should be placed in a beam or other solid surface. For drop ceilings, Da-Lite's T-Bar Clips may be purchased.

**SETTING UP YOUR SCREEN**

These illustrations (all rear views for simplification) show how easy the Deluxe Model B Screen is to operate.

1. To start unrolling the picture surface, pull down on cord pull knob. Then with hand resting on the handle, pull screen down.
2. The Automatic TENSIONIZER moves into position in a precision-like manner.
3. When surface is down, a simple press of contour-shaped handle locks it into position... ready for the show!
4. To re-roll picture surface—press firmly downward and counter-clockwise on flat handle to release lock. Permit surface to re-roll rapidly into case. Control upward movement by lightly holding handle or cord pull knob.

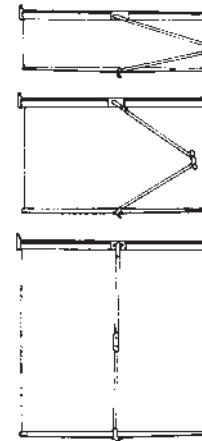

PROTECT YOUR SCREEN by keeping it rolled in its case when not in use. Always examine both front and back of surface before re-rolling into case to make certain screen is free of dust, dirt or other foreign matter. Use a very soft duster to gently remove any foreign particles.

**SCREEN ACCESSORIES**

**WALL BRACKETS**

Da-Lite No. 6 and No. 11 Non-adjustable wall brackets and No. 23 adjustable extension wall brackets are ideal for keystone elimination, chalkboard clearance, or corner mounting. The screen brackets should be fastened to the studding or other solid surface and not in the plaster only. Suspend screen from "D" rings.

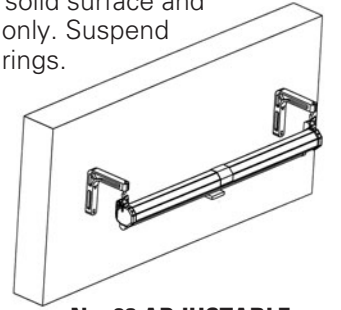

**No. 23 ADJUSTABLE WALL BRACKETS**

Screen can be extended 10"-24" from wall by wing nut and bolt adjustment.

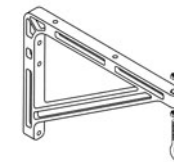
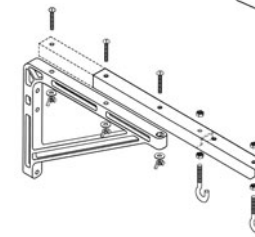

**No. 11 WALL BRACKETS**

Screen can be extended 10" or 14" from wall by changing position of bracket.



**No. 6 WALL BRACKETS**

Screen can be extended 6" from wall.

**T-BAR CLIP For Drop Ceilings**  
50 lb. max. load capacity.

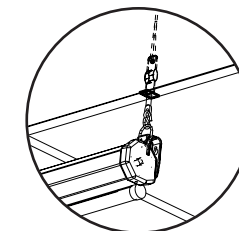

**TILT LOCK For Keystone Elimination**

Holds back bottom of screen in tilted position to eliminate keystoneing.

